

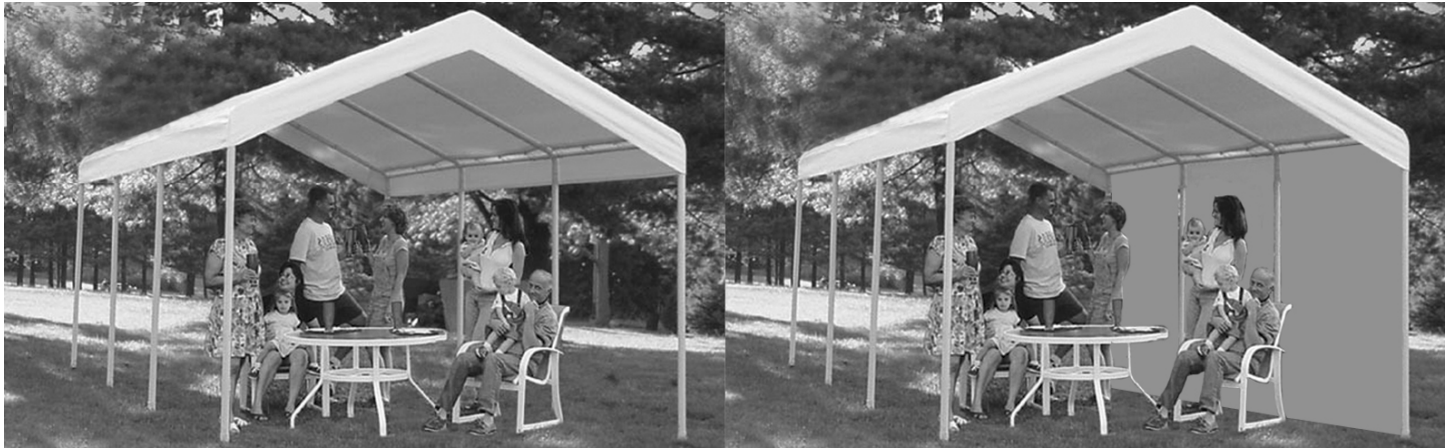









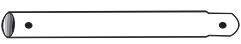
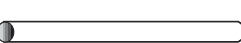
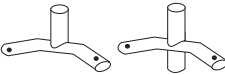

10 X 20 Model #23572 PREMIUM INDUSTRIAL CANOPY

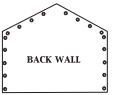
Please read instructions completely before assembly

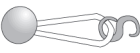

	Description	Qty.	Part #
	54.5" Swedged Rafter Poles	8	10091
	76" Swedged Leg Poles	8	10043
	77" Cross Poles 1 1/2"	9	10044
	(Top Bend, shallow bend) 3-Way Frame Connectors	2	10046
	4-Way Frame Connectors	2	10048
	(Side Bend, sharp bend) 3-Way Frame Connectors	4	10045
	4-Way Frame Connectors	4	10047
	All-Weather Cover	1	10302-2
	Side Walls	2	10082
	Back Wall	1	10301-2
	Double Zipper Door	1	10303-2
	Twist Tight™ Set (bungee & S hook)	4	10056
	Bungee Cords	104	10066
	Short Pins w/rings - 1/4" x 2 1/4"	8	10051
	Long Pins w/rings - 1/4" x 2 7/8"	8	10052
	Foot Plates	8	10050



150 Callender Road
Watertown, CT 06795

For assembly questions or replacement parts, Please call:
Consumer Support
1-800-524-9970

ATTENTION: PINS

8 -2 1/4" Pins secure legs to side bends.
8 -3 7/8" Pins secure feet plates to legs.

Pins are for legs and feet only, and are NOT needed for any other part of the frame.

05-1001 - rev. 1/28/02

This canopy must be anchored

1. FRAME ASSEMBLY

Assembly is easiest if you layout all parts as shown. There are eight - 54.5" x 2" **Rafter Poles**, they are swedged on both ends, and have 3 pre-drilled holes. The nine- 77" x 1.5" **Cross Poles** do not have swedged ends. You can set aside the eight- 76" x 2" **Leg Poles**, they are swedged on one end and have pre-drilled holes at the base & the top. It is very important that you determine which of the 3 & 4 way connectors are meant for the sides and which are for the crest. The side connectors have a sharper bend.

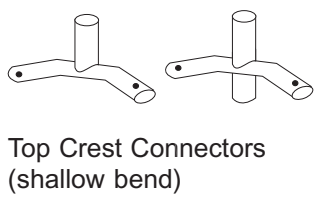
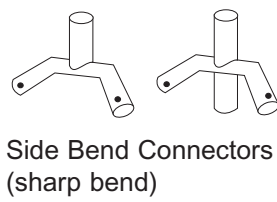
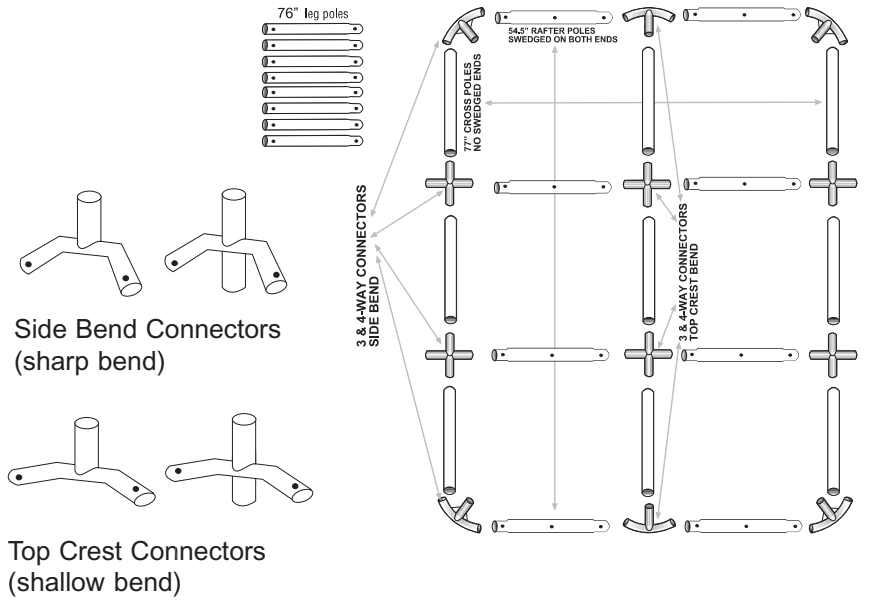

2. CONNECT PIPES

Start with the center, then assemble each side.

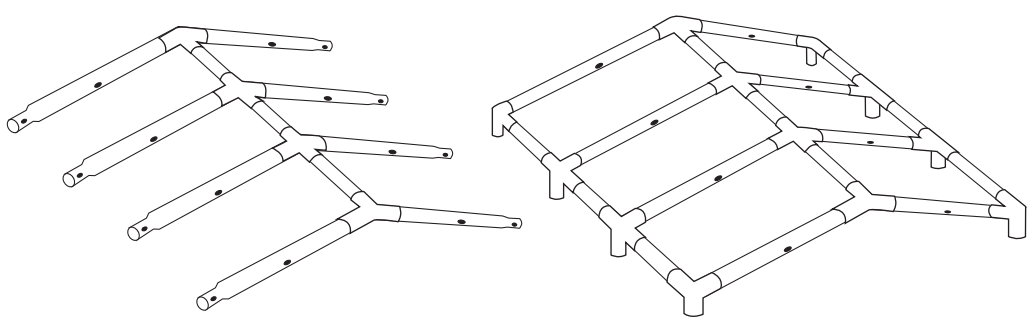

3. PLACE COVER

Place cover over frame so that the grommetted portion is face down, this allows the valance to wrap around and cover the frame eaves.

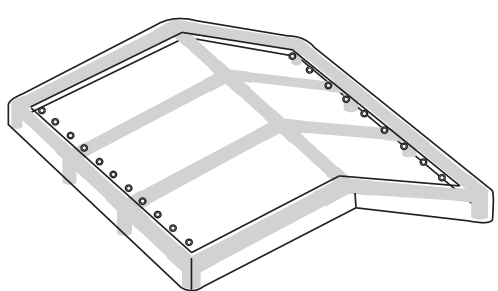

4. ATTACHING LEGS

Insert both middle legs on one side of the frame, swedged end up, then the end legs on that same side. Repeat for the other side. Now you can secure the legs to the side bend connectors and secure the cover with bungee cords.

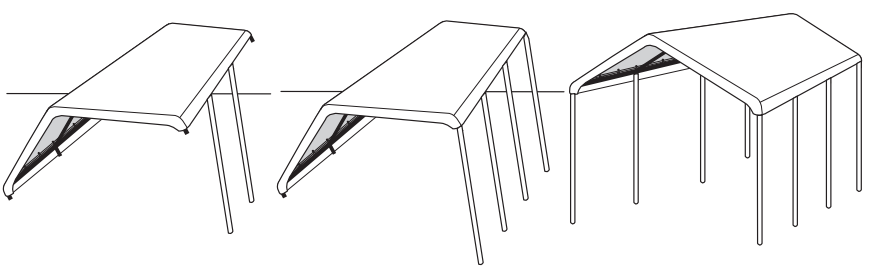

5. SECURING LEGS

8 Short Pins are used to secure legs to side bend connectors.

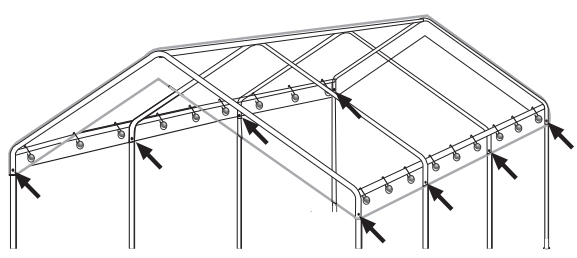

6. SECURING COVER

6.1 Working inside, under-neath the unit, begin with the corners. Insert the cord of the bungee-ball through the grommet and around the 77" Cross Pole, then around the ball. By doing this from the inside it will hide the bungee-ball and give a cleaner look. When all 4 corners are secured, work from side to side to get an even fit.

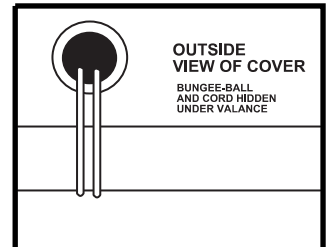
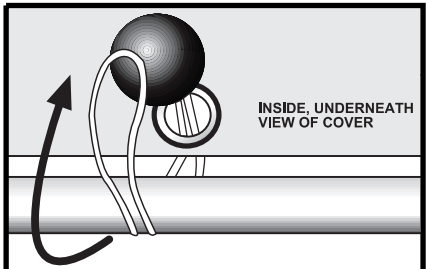

6. TwistTight^a

6.2 To get your cover to fit snugly over the frame, "twist" each corner leg pole equally until the cover becomes very tight. (picture A). Make sure to line up the hole in the top of the leg with the hole in the corner side bends.

6.3 Picture B To keep the leg in place, wrap the bungee cord around the cross rail, insert S hook into lined up hole of leg pole and 3 way connector. This will prevent the leg from "un twisting". Do this for each corner.

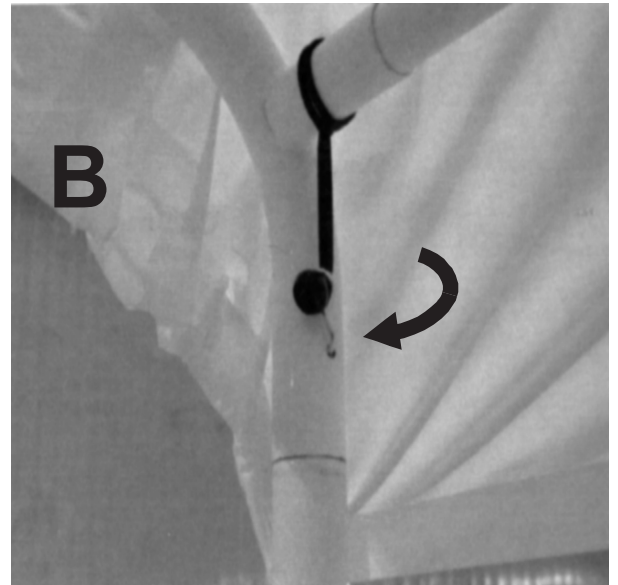

7. ATTACHING & SECURING BASE FEET

Insert Base Feet Plates onto bottom of legs, be sure to line up the pre-drilled hole in the leg with the pre-drilled hole in the base foot. Insert PIN all the way through leg and foot, to other side, secure with ring.

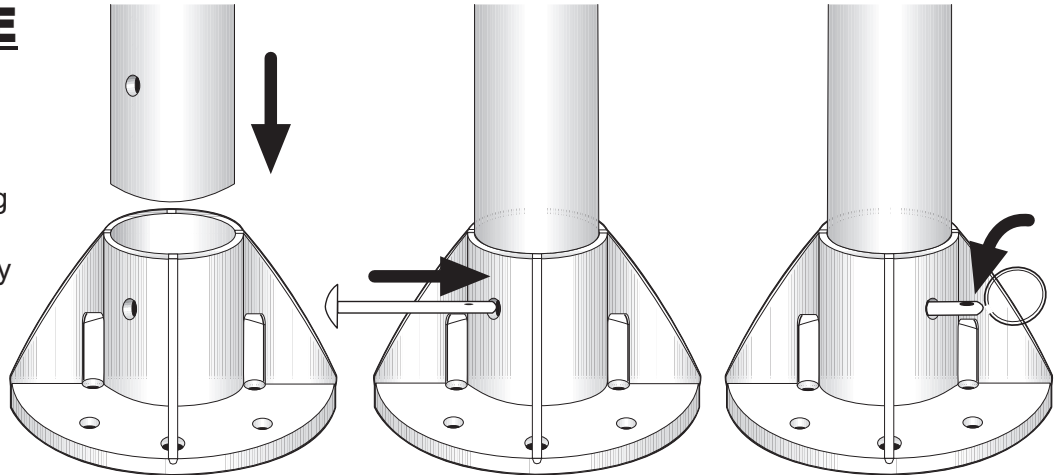

ATTACHING WALLS

Walls attach to unit by Bungee Cords. Thread bungee cord through grommets in wall and wrap around pole. If using more than one wall, attach all the walls at the top first, than work your way around the unit wrapping the bungee cords through both corners of the walls and legs.

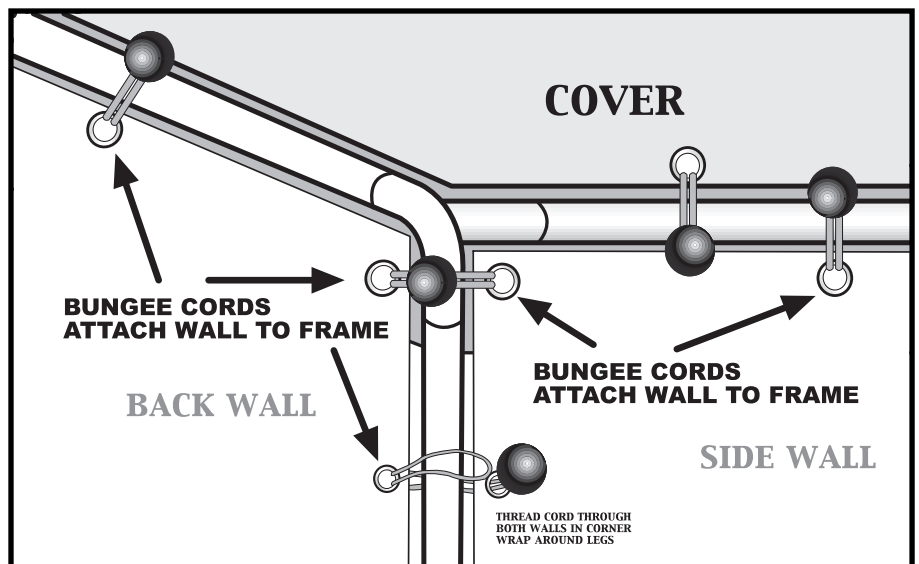
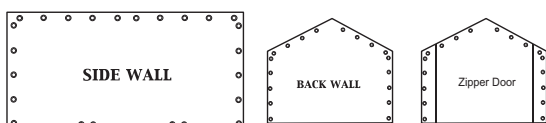

EASY ROLL-UP DOOR KIT

\$39.95

Locks Door in
any Position!

+ S&H

~~\$70.00~~

Item #10026

Call now to order the tube ropes , pulleys and
Hardware for a complete kit!



1-800-524-9970

Monday-Friday 8:00am-7:00pm EST

ANCHORING

Your All-Purpose Canopy is designed for use as a temporary structure that assembles in minutes without tools. After assembly your structure must be anchored to prevent damage.

Proper anchoring is your responsibility.

The preferred anchoring system uses screw in anchors and cable attached to each leg. Mobile home anchors will also work. Anchoring kits are available through our customer service department or you may go to your local home improvement or hardware store.

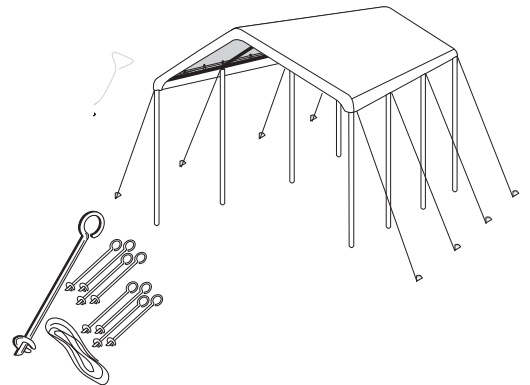

CARE & CLEANING INFORMATION

DO NOT expose top or walls to open fire or flame. **DO NOT** use barbeque grills or smokers underneath canopy.

DO NOT use harsh abrasives, bleach or cleansers. Cover and walls can be easily cleaned with mild soap and water. Periodically check stakes or anchors to ensure stability of unit, especially following exposure to high winds or heavy rain. **NOT** meant to hold snow load, brush snow off top with a broom or mop.

IMPORTANT:PLEASE READ CAREFULLY: ShelterLogic has no control over the elements such as wind, snow or heavy rain, we cannot be responsible for damage caused by the canopy or to the canopy. We suggest you contact your insurance carrier for information just as you would for any other outside structure.

This is a Temporary Structure and is not recommended as a permanent structure. Safety glasses must be worn when securing bungs.

Improper Anchoring, Strong Winds, Snow or Ice: ShelterLogic **does not guarantee these canopies in snow or ice under any**

circumstances. Canopies are designed to offer protection from damage caused by sun, light rain, tree sap, birds, and are not designed to hold the loads that accompany snow or ice. Any canopy that is not anchored securely or properly will fly away. We will not be responsible for any canopy that blows away. proper anchoring is your responsibility. We offer several anchoring kits, call customer service for more information or to place an order. Your canopy's cover can be quickly removed if needed when you know that a strong or severe weather front is approaching.

CAUTION! WARNING!

Bungee cords are under extreme tension. Please use caution when applying as they may snap out of your hand and cause injury. The use of safety goggles may help to prevent injury.