

12' x 20'

SUPER MAX CANOPY

Assembly Instructions

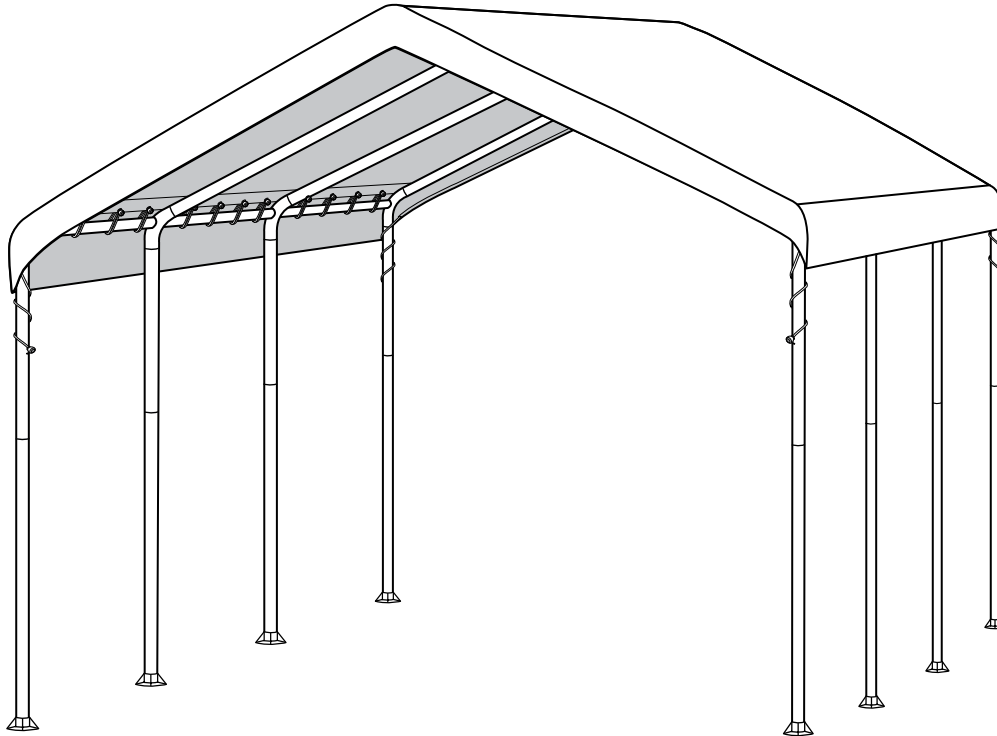

DESCRIPTION	MODEL #
12' x 20' Super Max Canopy - 8 Leg - White	25773

RECOMMENDED TOOLS

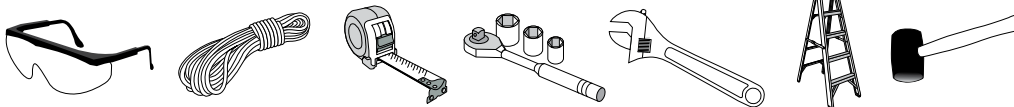

Please read instructions **COMPLETELY** before assembly. This shelter **MUST** be securely anchored. **THIS IS A TEMPORARY STRUCTURE AND NOT RECOMMENDED AS A PERMANENT STRUCTURE.**

Before you start: 2+ individual recommended for assembly, approximate time 2 hr.



150 Callender Road
Watertown, CT 06795
www.shelterlogic.com

ATTENTION:

This shelter product is manufactured with quality materials. It is designed to fit the **ShelterLogic®**, LLC custom fabric cover included. **ShelterLogic®**, LLC Shelters offer storage and protection from damage caused by sun, light rain, tree sap and animal - bird excrement. Please anchor this **ShelterLogic®**, LLC structure properly. See manual for more anchoring details. Proper anchoring, keeping cover tight and free of snow and debris is the responsibility of the consumer. This shelter is not recommended for severe weather conditions. Please read and understand the installation detail, warnings and cautions prior to beginning installation. If you have any questions call the customer service number listed below. Please refer to the warranty card inside this package.

DANGER:

Prior to installation, consult with all local municipal codes regarding installation of temporary shelters. Choose the location of your shelter carefully. **DANGER: Keep away from electrical wires.** Check for overhead utility lines, tree branches or other structures. Check for underground pipes or wires before you dig. DO NOT install near roof lines or other structures that could shed snow, ice or excessive run off onto your shelter. DO NOT hang objects from the roof or support cables.

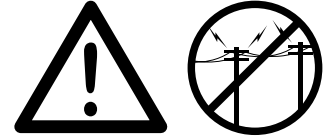

WARNING:

Risk of fire. DO NOT smoke or use open flame devices (including grills, fire pits, deep fryers, smokers or lanterns) in or around the shelter. DO NOT store flammable liquids (gasoline, kerosene, propane, etc.) in or around your shelter. Do not expose top or sides of the shelter to open fire or other flame source.



CAUTION:

Use **CAUTION** when erecting the frame. Use safety goggles during installation. Secure and bolt together overhead poles during assembly. Beware of pole ends.

PROPER ANCHORING AND INSTALLATION OF FRAME:











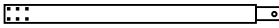
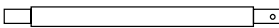

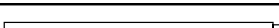

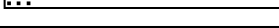
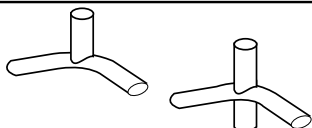
PROPER ANCHORING OF THE FRAME IS THE RESPONSIBILITY OF THE CONSUMER.

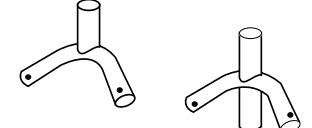
ShelterLogic®, LLC is not responsible for damage to the unit or the contents from acts of nature. Any shelter that is not anchored securely has the potential to fly away causing damage, and is not covered under the warranty. Periodically check the anchors to ensure stability of shelter. **ShelterLogic®**, LLC cannot be responsible for any shelter that blows away. **NOTE:** *Your shelter's cover can be quickly removed and stored prior to severe weather conditions.* If strong winds or severe weather is forecast in your area, we recommend removal of cover.

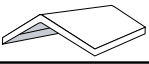
CARE AND CLEANING:

A tight cover ensures longer life and performance. Always maintain a tight cover. Loose fabric can accelerate deterioration of cover fabric. Immediately remove any accumulated debris from the roof structure with a broom, mop or other soft-sided instrument. Use extreme caution when removing debris from cover- always remove from outside the structure. DO NOT use hard-edged tools or instruments like rakes or shovels to remove debris. This could result in punctures to the cover. DO NOT use bleach or harsh abrasive products to clean the fabric cover. Cover is easily cleaned with mild soap and water.

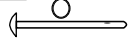
12' x 20' Super Max Canopy - 8 Leg - Parts List - Models #25773 / 30773

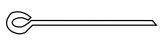
Description of Parts:		Quantity	Part #
	35" Rafter Tubes	8	800240
	35" Rafter Tubes, Swaged	8	800241
	39.4" Upright Poles	8	800243
	39.4" Upright Poles	8	10093
	40" Top Cross Rails	9	10161
	40" Top Cross Rails	9	10162
	3-Way Frame Connectors (Top bend, shallow bend)	2	10046
	4-Way Frame Connectors	2	10048
	3-Way Frame Connectors (Side bend, sharp bend)	4	10045
	4-Way Frame Connectors	4	10047
	Polyethylene Fabric Cover (White)	1	10049
	Foot Plates	8	10050
	Bungee Cords	24	10066
	Short Pins with Rings - 1/4" x 2 1/4"	4	10051
	Long Pins with Rings - 1/4" x 2 7/8"	8	10052
	TwistTite™ Set (bungee with "S" hook)	4	10056
	Anchors	8	10431

FRAME ASSEMBLY OVERVIEW

- 01 10046
- 02 10048
- 03 10045
- 04 10047
- 05 800240
- 06 800241
- 07 800243
- 08 10093
- 09 10161
- 10 10162

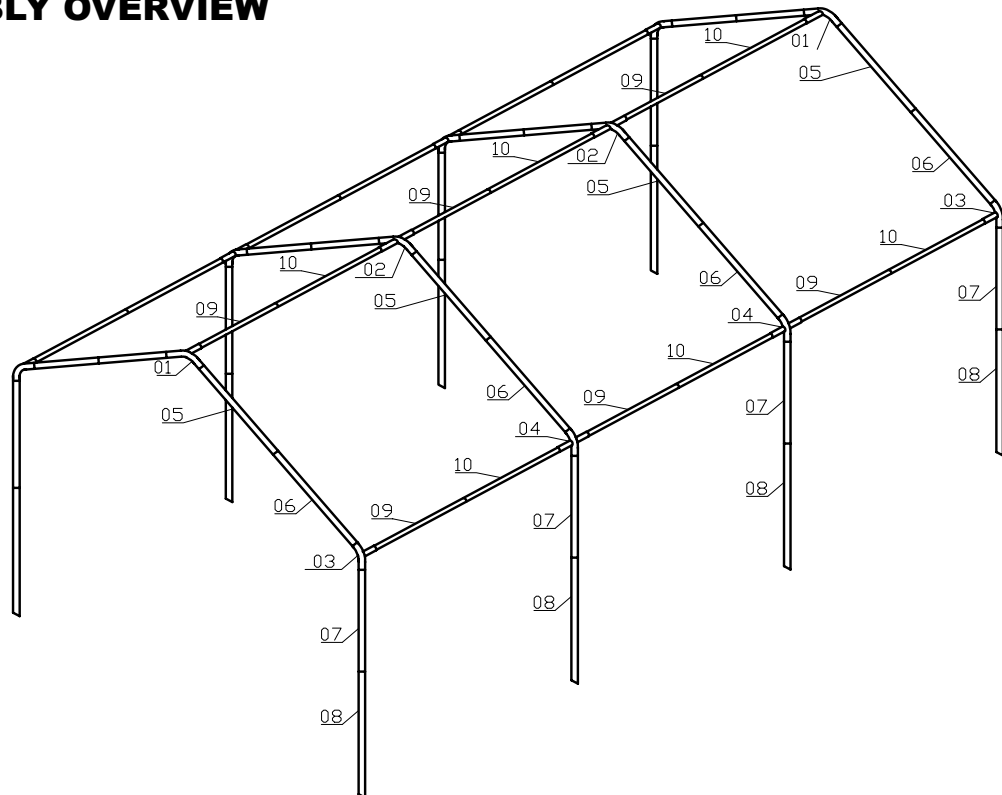

1. Pre-Assembly: LAY OUT the ROOF FRAME

Assembly is easiest if you layout all parts as shown in the area you intend to erect the shelter. Keep all non pipe parts on a tarp or box top.

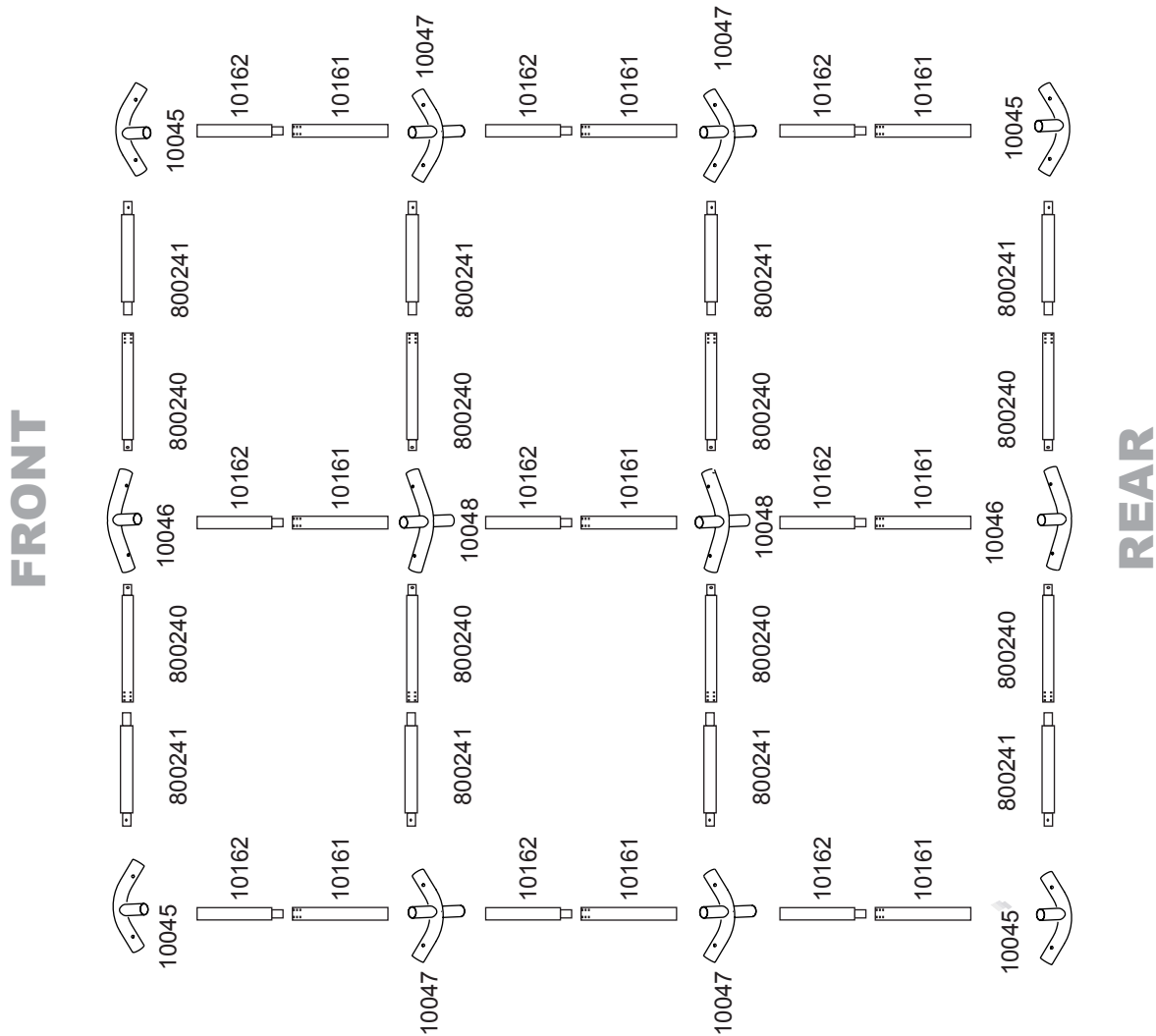

2. ASSEMBLE ROOF FRAME

Start with the center rafters, then assemble each side.

NOTE: Swedged tubes insert into plain ends at the crimp marks.

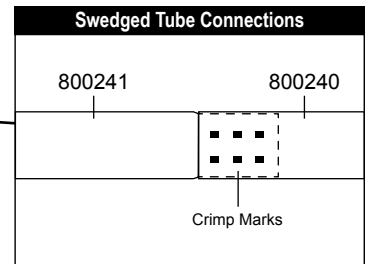
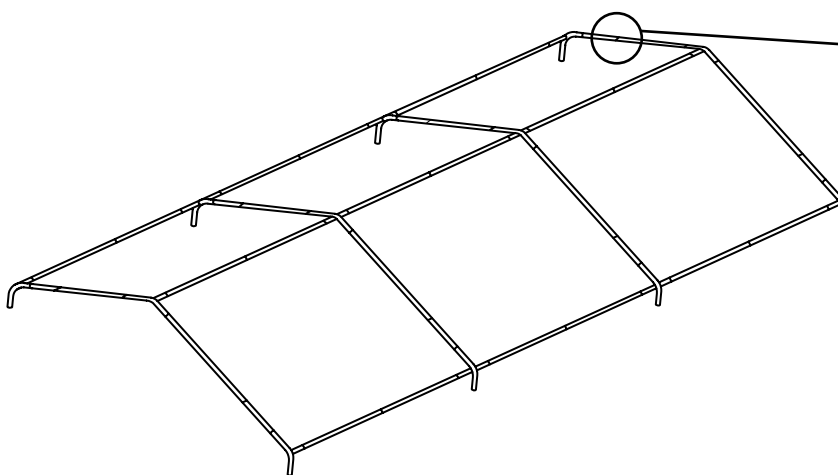

3. ASSEMBLE LEGS & ATTACH TO ROOF FRAME

Attach all legs to one side first. Let the other side of roof frame rest on the ground. Repeat for opposite side.

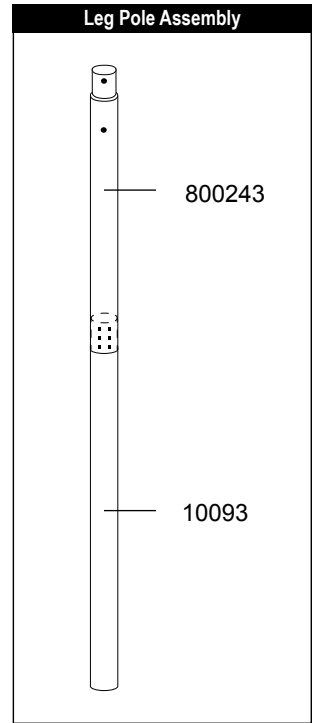
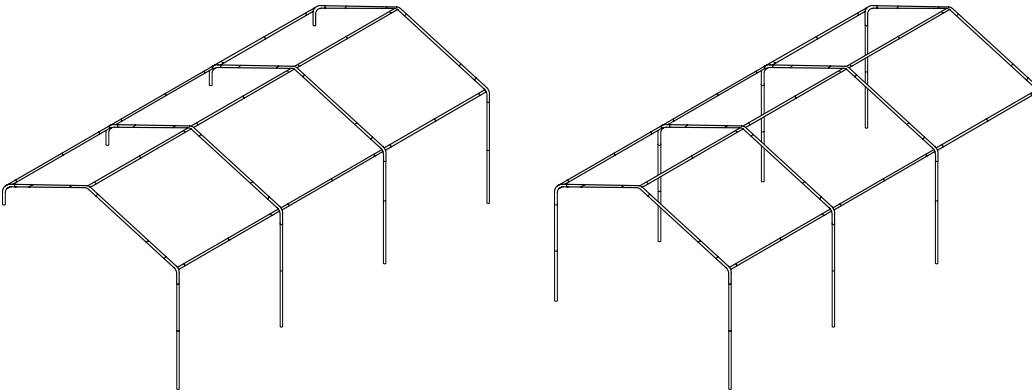

4. SECURE LEGS

To secure the legs to the roof assembly, insert pins through the hole at the bottom of each of the 4-way connectors. Rotate the legs, if necessary, to align the holes. This will complete the leg assembly for this side. Repeat for the other side.

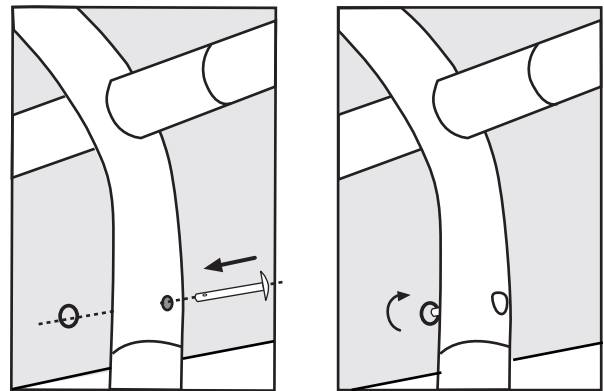

5. ATTACH FEET & ANCHOR CANOPY

- A. Insert the legs into the foot plates. Align holes.
- B. Insert one long pin (10052) through all eight legs to secure base foot. Repeat with each leg.
- C. There are four holes on each base foot that the anchor can go into. Select a hole in each base foot. Insert each anchor into the ground until the round head is touching the base foot.
- D. Insert one anchor into all eight base feet.

This is a temporary spike anchor. Not intended for permanent use.

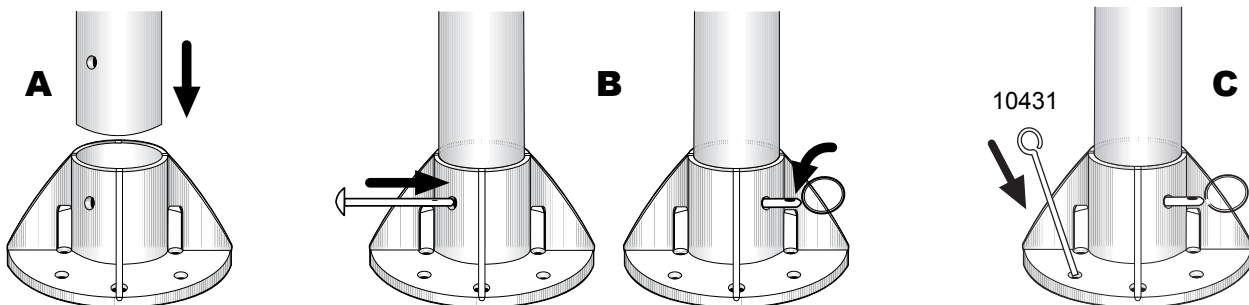

6. PLACE COVER AND SECURE TO CANOPY FRAME

- A. Place cover over assembled roof frame with grommet panels facing down, aligned with cross rails.
- B. Make sure the cover is properly aligned on the frame, secure the four corners of the cover with bungees (10066) to the frame first. Attach remaining bungees.

Re-adjust bungees position along cross pole as needed to ensure a tight and even fit of the cover to the frame.

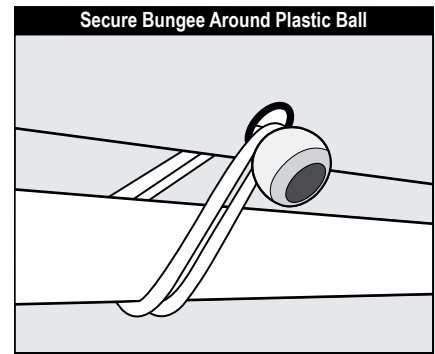
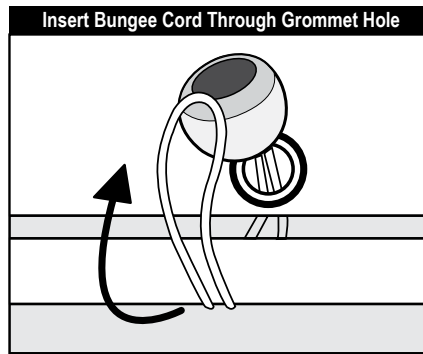
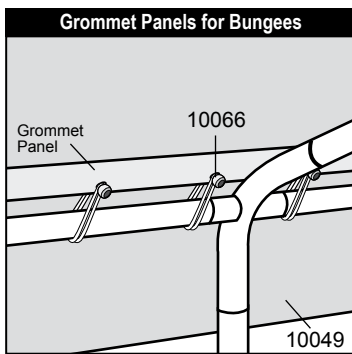
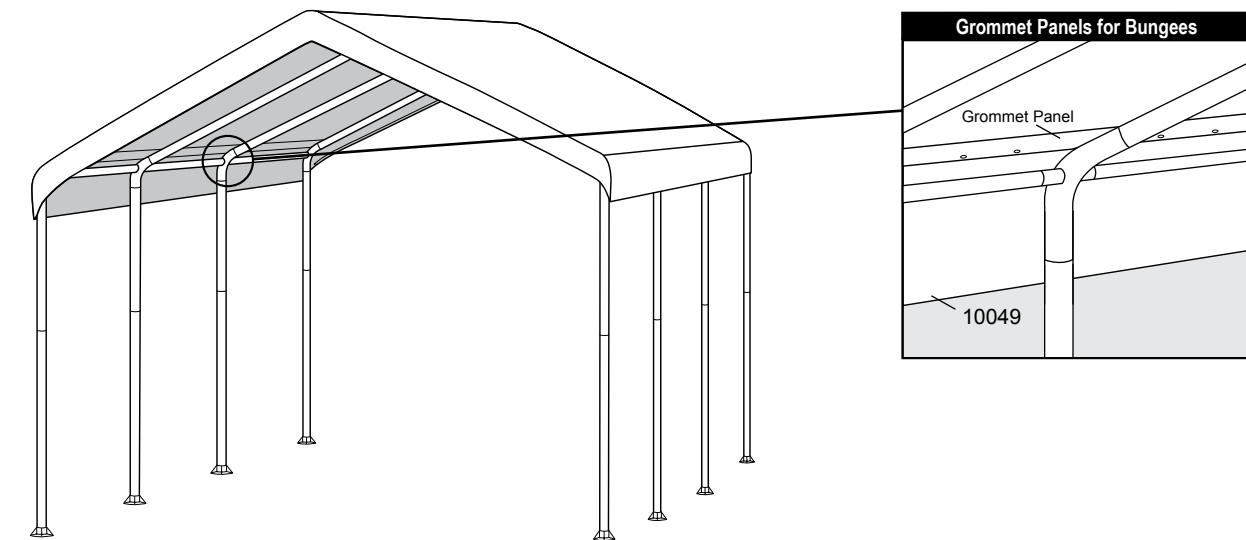

7. TIGHTEN THE COVER WITH TWIST TITE™

- A. Wrap the cord with plastic ball and "S" hook at the corners of the cover around the corner leg poles. Insert "S" hook into the hole of the corner leg poles.
- B. Twist each leg pole toward the inside of the shelter until the cover becomes tight. Twist the leg poles equally to ensure the cover stays aligned during tightening.
- C. To keep leg in place, wrap the bungee cord around the cross rail, insert the "S" hook into the lined up hole of the leg pole and 3-way connector. Repeat for each corner.

