

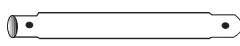

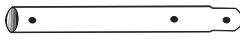

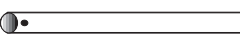

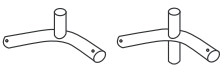

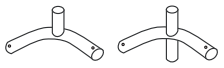
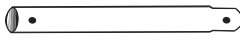
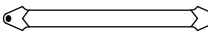

18 X 30 Model #26767 PREMIUM INDUSTRIAL CANOPY

Please read instructions completely before assembly

	Description	Qty	Part #
	71" Swedged Rafter Poles	12	802105
	76" Swedged Leg Poles	12	10043
	69.6" Cross Poles	15	10244
	(Top Bend, shallow bend) 3-Way Frame Connectors	2	10046
	4-Way Frame Connectors	4	10048
	(Side Bend, sharp bend) 3-Way Frame Connectors	4	10045
	4-Way Frame Connectors	8	10047
	38.5" Swedged Rafter Poles	12	802104
	Truss	6	802103
	All-Weather Cover	1	10169
	Bolts 1/4" x 2 1/2"	24	10017
	Nuts 1/4"	12	1010
	Wing Nuts	12	7000
	Twist Tite™ Set (bungee & S hook)	4	10056
	Bungee Cords	36	10066
	Long Pins w/rings 1/4" x 2 7/8"	12	10052
	Short Pins w/rings 1/4" x 2 1/4"	8	10051
	Feet Plates	12	10050
	Anchors	12	10431



WARNING!

Use CAUTION when assembling this unit. Manufacturer requires the use of safety goggles during assembly. Bungees are under extreme tension and may snap out of your hand and cause injury. Be aware of poles over your head during assembly that may not be secured, and could fall and cause injury. Do not assemble near electrical overhead wires. Three or more persons are recommended to assemble this shelter. Estimated assembly time 2 hours.



www.shelterlogic.com
1-800-524-9970
Canada 1-800-559-6175

150 Callender Road
Watertown, CT 06795

Manufactured Under
U.S. Patents
D415,571 D409,310
D430,306 D414,564
Other Patents Pending

Recommended Tools

Safety Glasses



Step Ladder

For safety reason never use the top step of the ladder.



Utility knife



Rubber Mallet



Tape measure



1. Frame Assembly

Assembly is easiest if you layout all parts as shown. There are (12) #802105 Rafter Poles, they are swaged on both ends. (12) #802104 Rafter Poles, they are swaged end. The (15) #10244 Cross Poles do not have swaged ends. It is very important that you determine which of the 3 & 4 way connectors are meant for the sides and which are for the crest.

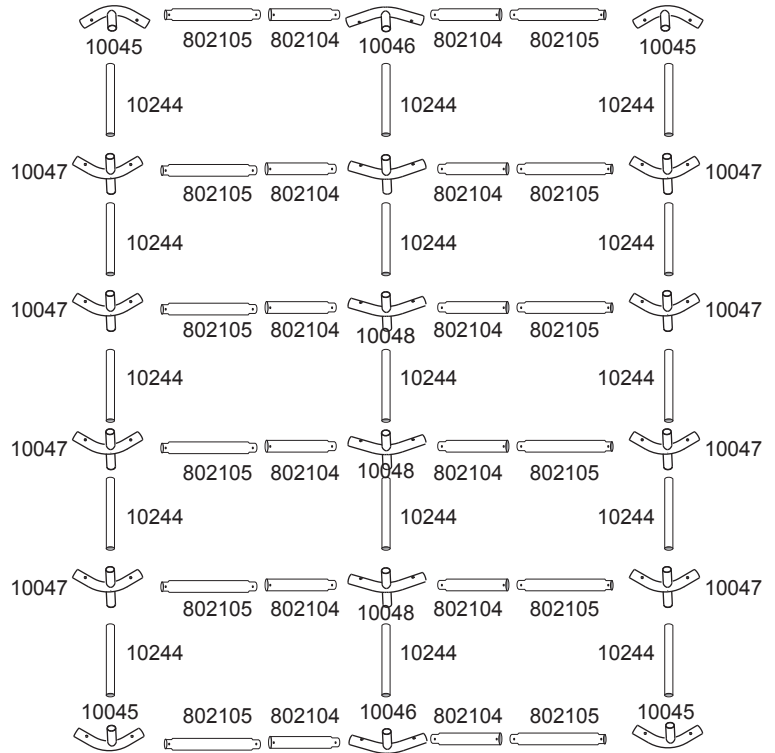
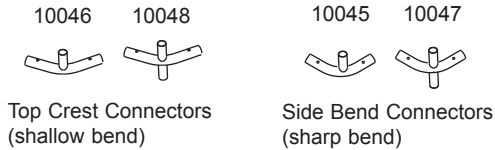

2. Assemble Roof

Start with center, Fig. 1, using layout shown in diagram above. Bolt roof assembly together as shown in Fig. 1A. Assemble each side of the roof as shown in Fig. 2. Install #802103 truss brace roof as shown in Fig. 2A.

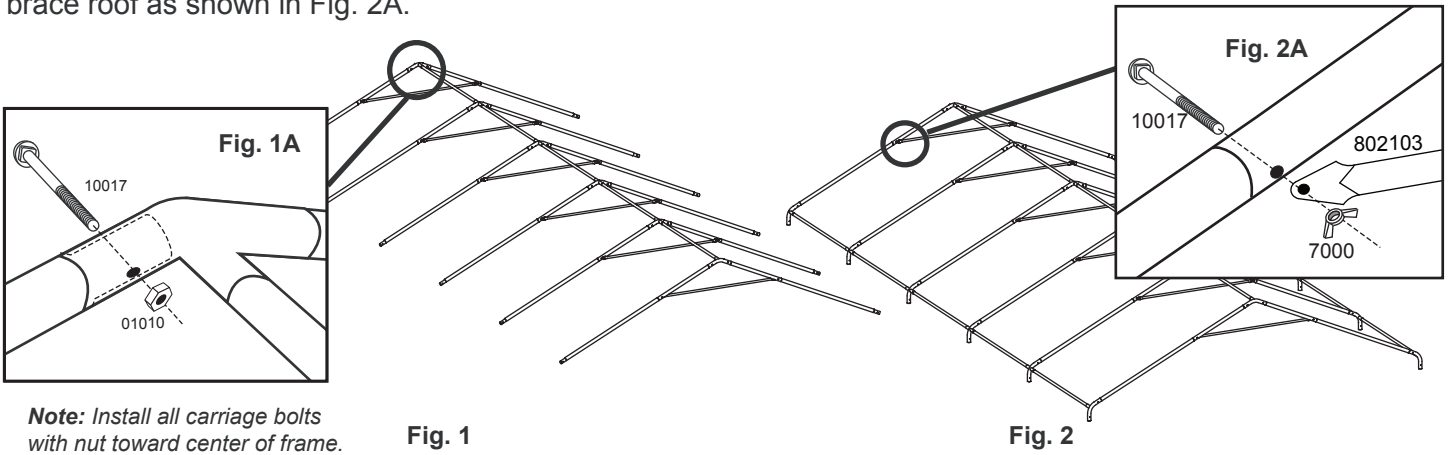

3. Place Cover

Place cover over frame so that the grommeted portion is face down, this allows the valance to wrap around and cover the frame eaves.

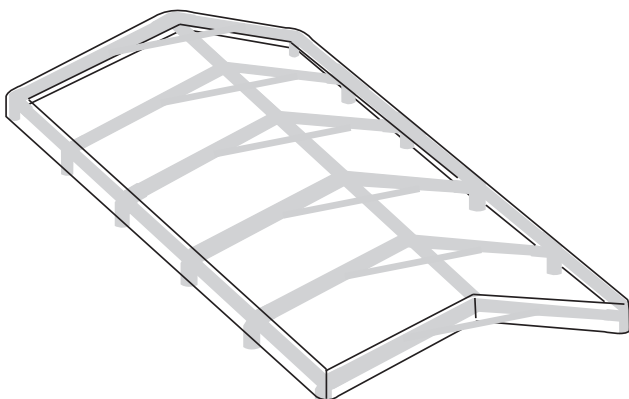

4. Attaching Legs

Insert #10043 Leg Poles on one side of the frame, swaged end up, then the end legs on that same side. Repeat for the other side. Now you can secure the legs to the side bend connectors and secure the cover with bungee cords.

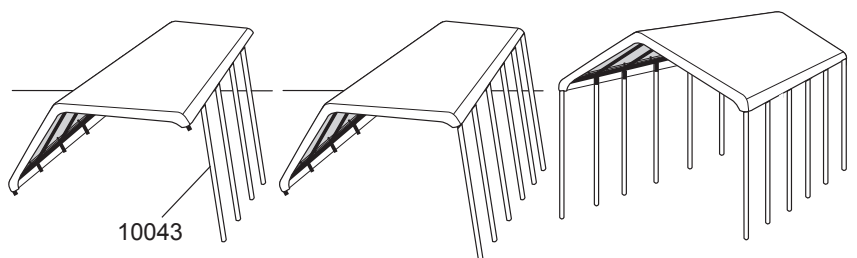

5. Securing Legs

Short Pins are used to secure legs to side bend connectors.

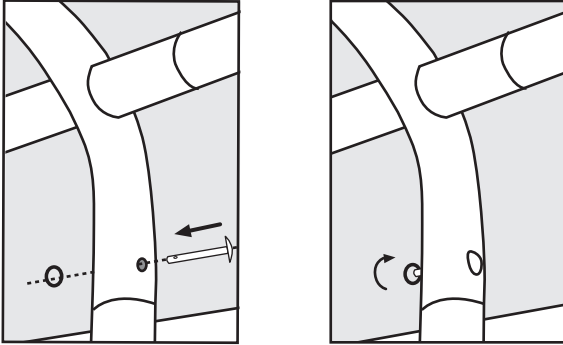

6. Securing Cover

Working inside, under-neath the unit, begin with the corners. Insert the cord of the bungee-ball through the grommet and around the Cross Pole, then around the ball. By doing this from the inside it will hide the bungee-ball and give a cleaner look. When all 4 corners are secured, work from side to side to get an even fit.

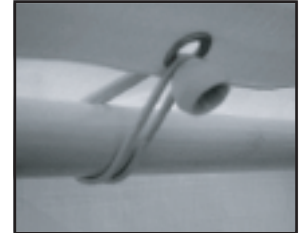
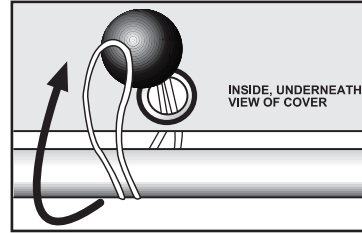

7. Twist Tite™

7.1 To get your cover to fit snugly over the frame, "twist" each corner leg pole equally until the cover becomes very tight. (picture A). Make sure to line up the hole in the top of the leg with the hole in the corner side bends.

7.2 Picture B To keep the leg in place, wrap the bungee cord around the cross rail, insert "S" hook into lined up hole of leg pole and 3 way connector. Do this for each corner.

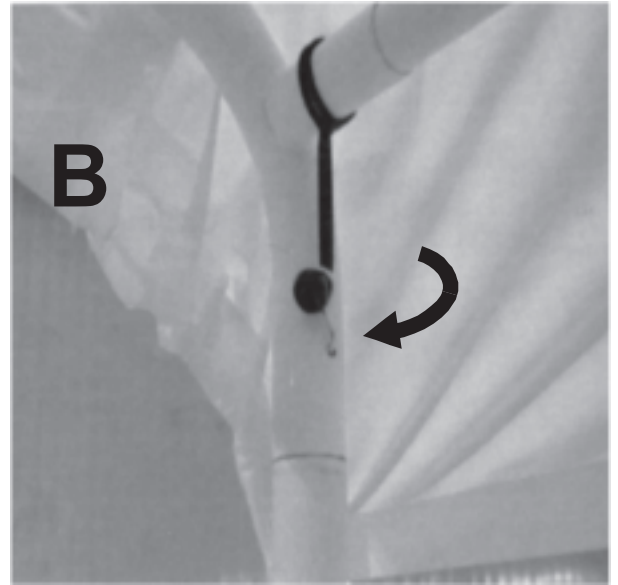

8. Attaching & Securing Base Feet

Insert Base Feet Plates onto bottom of legs, be sure to line up the pre-drilled hole in the leg with the pre-drilled hole in the base foot. Insert long pins all the way through leg and foot, to other side, secure with ring.

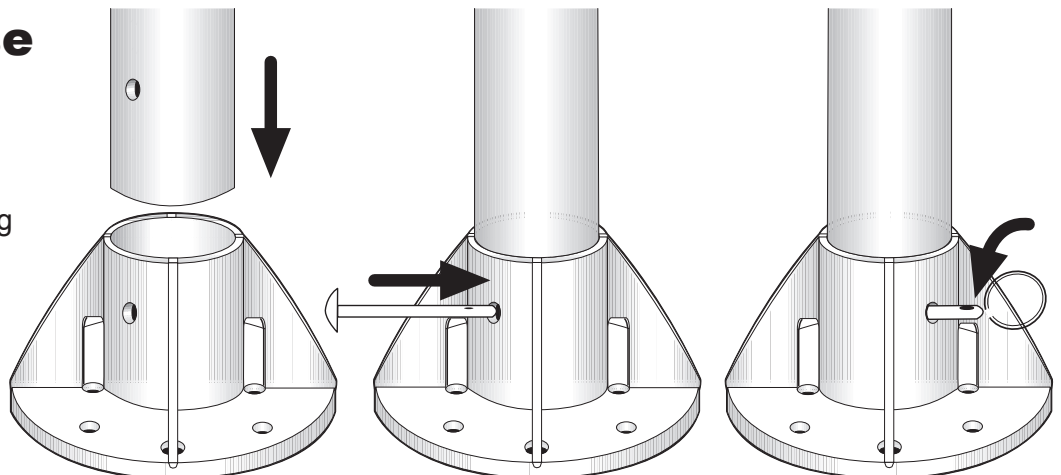

9. Anchoring

Locate a suitable location to place one anchor as shown in the illustration into each of the base feet until the round end of the anchor touches the base feet.

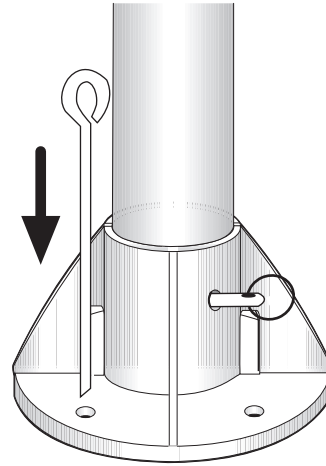

WARNINGS, CAUTIONS, CARE & CLEANING

Warning!

- Prior to installation, check all local and municipal laws regarding these shelters.
- Choose your shelter's location carefully.
- Check for overhead utility lines, branches, etc.
- Do NOT install near roofs or other structures that may shed snow or ice onto shelter.
- Do NOT hang objects from the roof structure or cables.
- Do NOT smoke or use open flame devices near the shelter.
- Do NOT store flammable liquids (eg. Gasoline, Kerosene, etc.) in your shelter.
- Do NOT expose top or sides to open fire or flame.
- Do NOT use barbeque grills, fire pits, deep fryers or smokers inside this shelter.
- Be sure to remove any accumulated snow from roof. Care should be used when removing snow to prevent punctures being made in the cover with rakes, shovels, etc.
- Bungee cords are under extreme tension. Please use caution when applying as they may snap out of your hand and cause injury. Manufacturer requires the use of safety goggles during assembly.

Caution!

- This shelter is intended to protect against the effects of sun, rain, tree sap, bird droppings, light snow, etc.
- It is not designed to hold the loads that can accompany heavy wind, deep snow or ice storms.
- Proper anchoring is the responsibility of the user.
- Please read and understand all warnings prior to permanent installation.
- Any canopy that is not anchored securely or properly will fly away. We will not be responsible for any canopy that blows away.
- Proper anchoring is your responsibility.
- Your canopy's cover can be quickly removed if needed when you know that a strong or severe weather front is approaching.

Care & Cleaning

- Bungee cords are under extreme tension. Please use caution when applying as they may snap out of your hand and cause injury. Safety goggles must be worn when securing bungees.
- During the first few months of use, it will be necessary to tighten the cover a few times.
- Be sure that the cover is kept tight, loose fabric will deteriorate quickly.
- Do NOT apply any "Protect & Shine" type products to the cover and ends or use any harsh or abrasive cleaners. The cover may be cleaned with mild soap and water.